

Technical Datasheet

BERNATI

BCL Series - Aluminum frame three phase low voltage electric motor

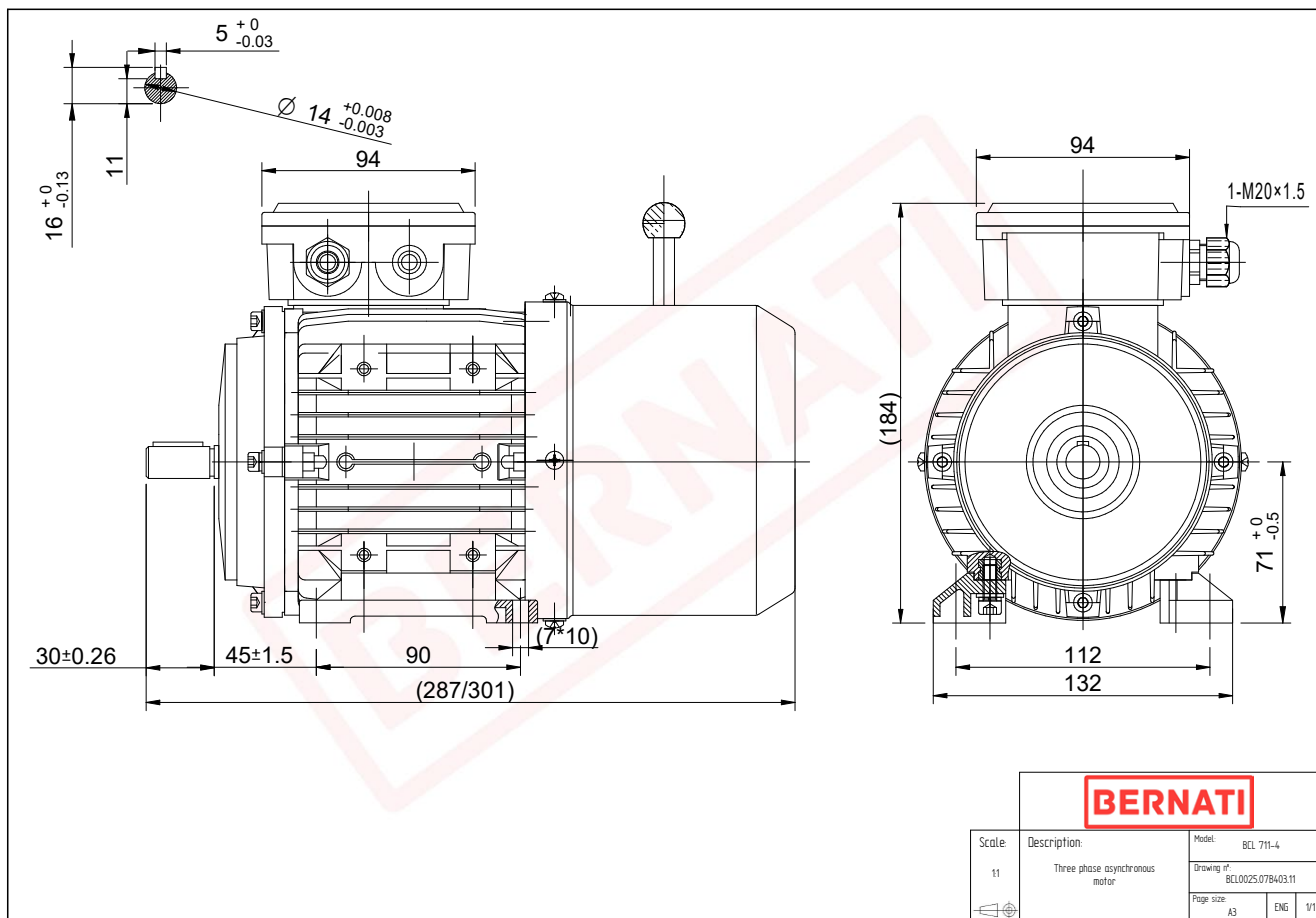

BCL

Product Code	BCL0025.07B403.11
Motor Type/Frame	BCL 711-4
Mounting	IM B3
Output Power (kW)	0.25
Speed (rpm)	1395
Tension (V)	230/400
Frequency (Hz)	50
Current (A)	0.80
Power factor (Cos Ø)	0.70
Poles	4
Insulation Class	F
IP Class	IP55
50% Efficiency	55.8
75% Efficiency	63.1
100% Efficiency	65.1
Tstart / Tnominal	2.00
Istart / Inominal	4.20
Tmax / Tnominal	2.20
Noise (dB)	55
PTC Thermistor	N/A
Weight (Kg)	6
DE Bearing	6202 2RZ C3
NDE Bearing	6202 2RZ C3