

Technical Datasheet

BERNATI

BCL Series - Aluminum frame three phase low voltage electric motor

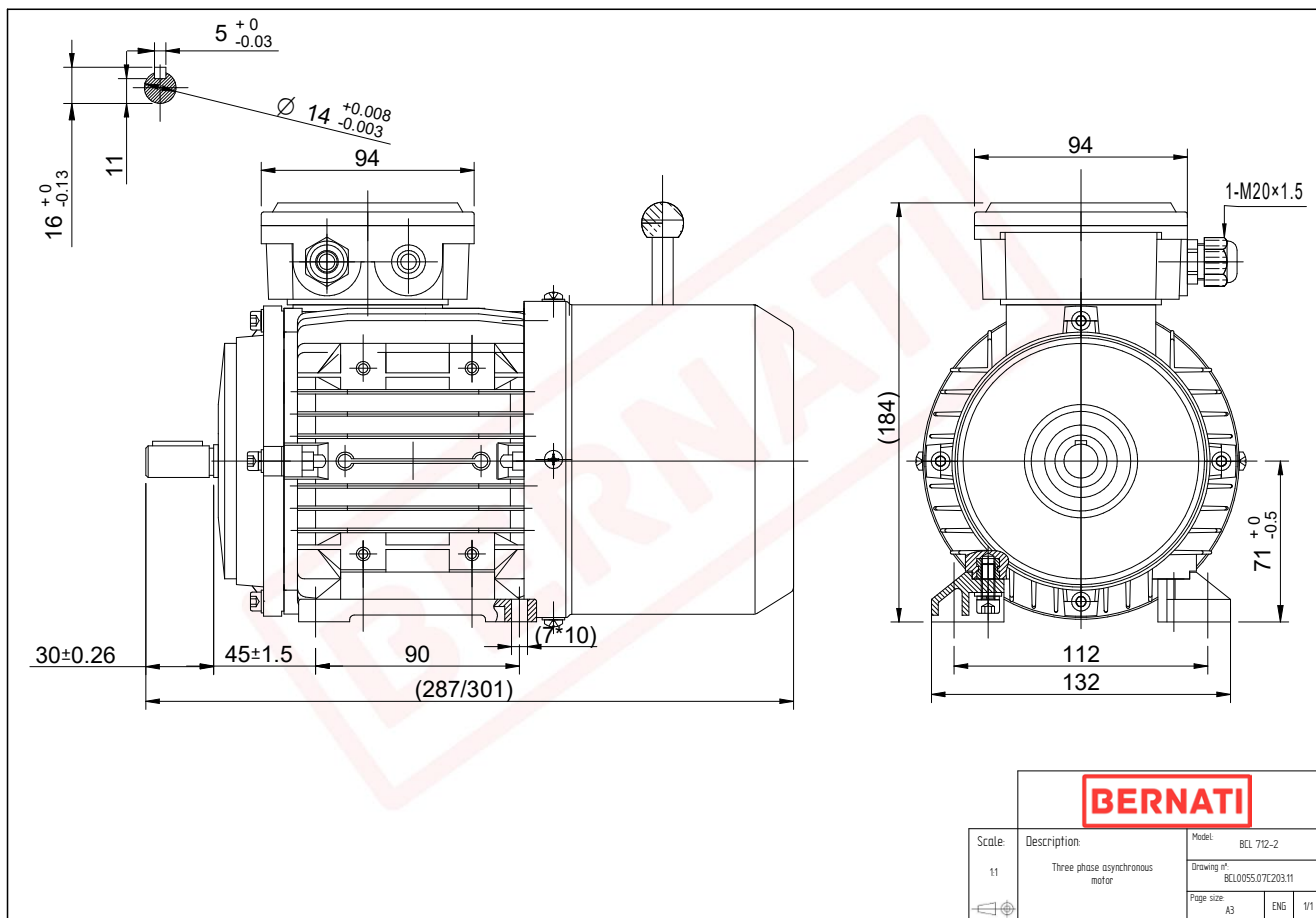

BCL

Product Code	BCL0055.07C203.11
Motor Type/Frame	BCL 712-2
Mounting	IM B3
Output Power (kW)	0.55
Speed (rpm)	2815
Tension (V)	230/400
Frequency (Hz)	50
Current (A)	1.40
Power factor (Cos Ø)	0.80
Poles	2
Insulation Class	F
IP Class	IP55
50% Efficiency	66.1
75% Efficiency	71.0
100% Efficiency	71.6
Tstart / Tnominal	2.70
Istart / Inominal	6.00
Tmax / Tnominal	2.70
Noise (dB)	64
PTC Thermistor	N/A
Weight (Kg)	7
DE Bearing	6202 2RZ C3
NDE Bearing	6202 2RZ C3