

Data Sheet

BV Series - BVC Type

Type	i-ratio	n2 r/min	Kw=P1	Nm=T2
BVC 030/040	245	5.7	0.09	58
	350	4.0	0.09*	58
	420	3.3	0.09*	58
	560	2.5	0.09*	58
	700	2.0	0.09*	58
	840	1.7	0.09*	58
	1120	1.3	0.09*	58
	1680	0.8	0.09*	58
	2100	0.7	0.09*	58
	2760	0.5	0.09*	50

Type	i-ratio	n2 r/min	Kw=P1	Nm=T2
BVC 030/063	240	5.8	0.25	194
	315	4.4	0.18	164
	450	3.1	0.18	200
	570	2.5	0.12	180
	720	1.9	0.12	200
	900	1.6	0.12	200
	1200	1.2	0.12	200
	1520	0.9	0.09*	200
	2280	0.6	0.09*	200
	2700	0.5	0.09*	200

Type	i-ratio	n2 r/min	Kw=P1	Nm=T2
BVC 030/050	240	5.8	0.12	77
	315	4.4	0.12	90
	420	3.3	0.09	90
	540	2.6	0.09	90
	720	1.9	0.09*	90
	900	1.6	0.09*	90
	1120	1.3	0.09*	90
	1440	0.9	0.09*	90
	2160	0.6	0.09*	90
	2700	0.5	0.09*	90

Type	i-ratio	n2 r/min	Kw=P1	Nm=T2
BVC 040/075	250	5.6	0.37	360
	300	4.7	0.37	360
	400	3.5	0.25	315
	525	2.7	0.25	360
	700	2.0	0.18	360
	920	1.5	0.18	360
	1200	1.2	0.12	360
	1500	0.93	0.12*	360
	2100	0.67	0.12*	360
	2800	0.5	0.12*	360

	Y
BVC 030/040	120.5
BVC 030/050	125.5
BVC 030/063	165
BVC 040/075	192
BVC 040/090	204.5

Type	i-ratio	n2 r/min	Kw=P1	Nm=T2
BVC 040/090	230	5.6	0.55	460
	300	4.7	0.55	490
	400	3.5	0.55	490
	525	2.7	0.37	490
	700	2.0	0.37	490
	920	1.5	0.25	490
	1380	1.2	0.18	490
	1840	0.93	0.18	490
	2116	0.67	0.12	490
	2760	0.5	0.12	490

Power marked with (*) are greater than those permitted by the gear unit. Therefore, the choice should be made according to the torque and not the power. The gear ratios are the most requested, so it is possible to obtain multiple combinations using the various ratios of the two individual gearboxes.

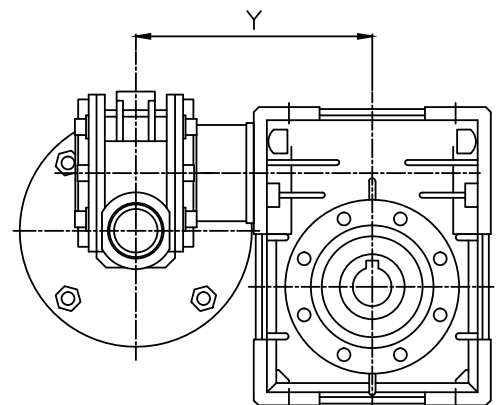
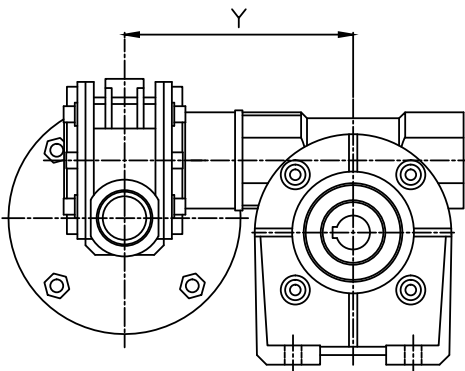

Data Sheet

BV Series - BVC Type - BVC 040/075

Type	i-ratio	n2 r/min	Kw=P1	Nm=T2	f.s.	PAM IEC	
BVC 040	7	200	0.55*	22	1.4	71/63	B5/B14
	10	140	0.55*	30	1.0	71/63	B5/B14
	14	100	0.37	29	1.0	71/63	B5/B14
	20	70	0.37	38	1.0	71/63	B5/B14
	28	50	0.37	40	0.9	71/63	B5/B14
	35	40	0.25	41	0.9	71/63	B5/B14
	46	30	0.18	37	1.0	63	B5/B14
	60	23	0.18	37	0.9	63	B5/B14
	70	20	0.12	33	0.9	63	B5/B14
	100	14	0.12	30	0.9	63	B5/B14

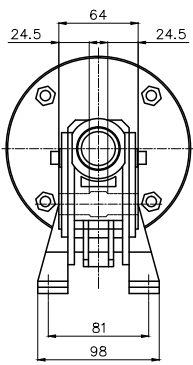

A

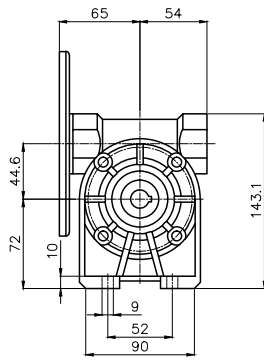

P

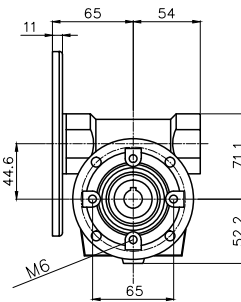
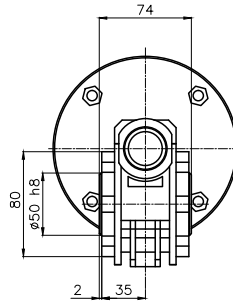

Gearbox Dimensions

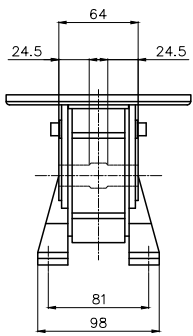

N

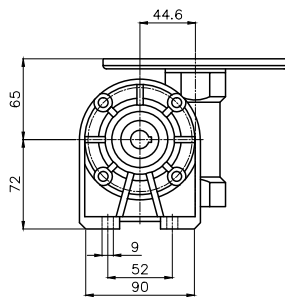

F

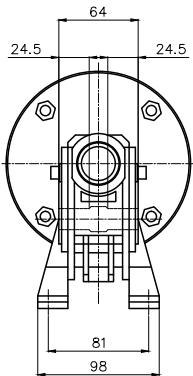
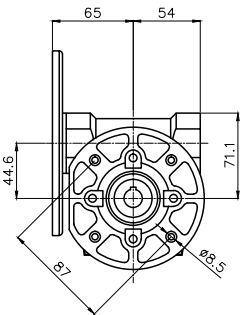
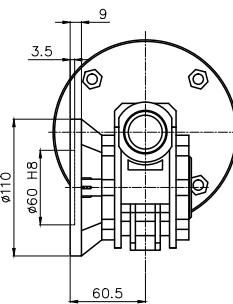

A

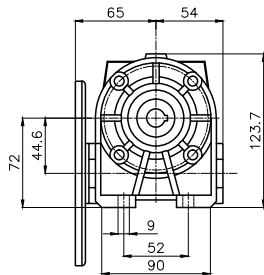

FA

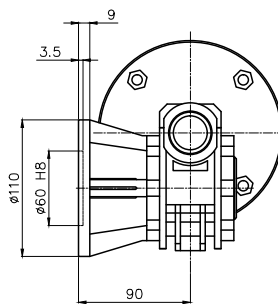

Data Sheet

BV Series - BVC Type - BVC 040/075

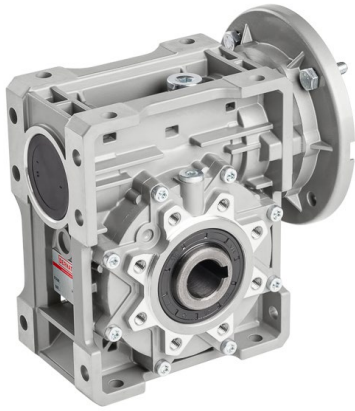

Type	i-ratio	n2 r/min	Kw=P1	Nm=T2	f.s.	PAM IEC	
BVC 075	7	200	4	170	1.1	100/90	B5/B14
	10	140	3	175	1.3	100/90	B5/B14
	15	93	3	250	1.0	100/90	B5/B14
	20	70	2.20	240	1.0	100/90	B5/B14
	25	56	1.5	203	1.2	90/80	B5/B14
	30	47	1.50	230	1.2	90/80	B5/B14
	40	35	1.1	215	1.2	90/80	B5/B14
	50	28	1.1	220	0.9	90/80	B5/B14
	60	23	0.75	200	1.0	90/80	B5/B14
	80	17	0.55	180	1.0	80/71	B5/B14*
	100	14	0.37	140	1.1	80/71	B5/B14*

* 71 only B5

Gearbox Dimensions

