

Data Sheet

BV Series - BVS Type - BVS 040

Type	A	B	C	D(H7)	d(h6)	f	H	I	R	b	t
BVS 030	20	50	-	14	9	-	55	30	55	5	16,3
BVS 040	30	54	-	18	11	-	72	44,6	64	6	20,8
BVS 050	40	65	-	25	16	M6	82	49,5	82	8	28,3
BVS 063	40	110,5	-	25	18	M6	72,5	62,17	120	8	28,3
BVS 075	40	128	-	30	19	M6	87	75	127	8	33,3
BVS 090	50	144	-	35	25	M8	100	86,9	140	10	38,3

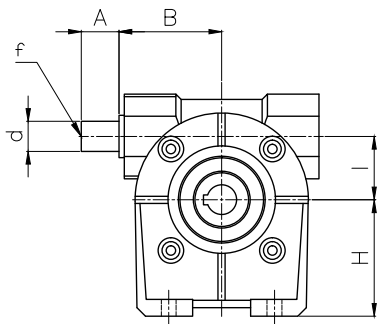

BVS 030-040-050

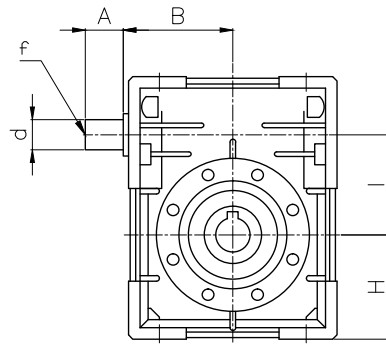

BVS 063-075-090

Output shaft dimensions

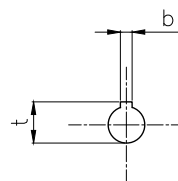
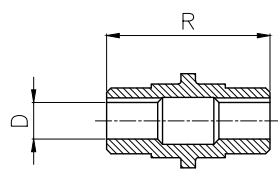

Data Sheet

BV Series - BVSB Type - BVS 040

Type	i-ratio	n2 r/min	Kw=P1	Nm=T2	f.s.	PAM IEC	
BVS 040	7	200	0.55*	22	1.4	71/63	B5/B14
	10	140	0.55*	30	1.0	71/63	B5/B14
	14	100	0.37	29	1.0	71/63	B5/B14
	20	70	0.37	38	1.0	71/63	B5/B14
	28	50	0.37	40	0.9	71/63	B5/B14
	35	40	0.25	41	0.9	71/63	B5/B14
	46	30	0.18	37	1.0	63	B5/B14
	60	23	0.18	37	0.9	63	B5/B14
	70	20	0.12	33	0.9	63	B5/B14
	100	14	0.12	30	0.9	63	B5/B14

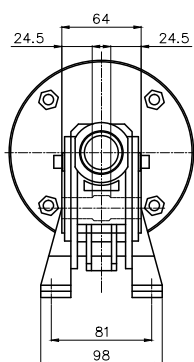

A

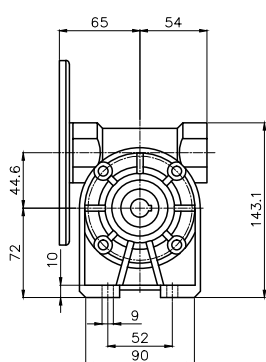

P

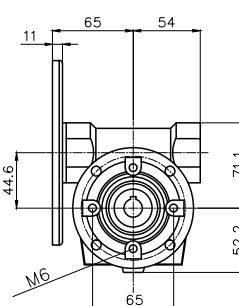
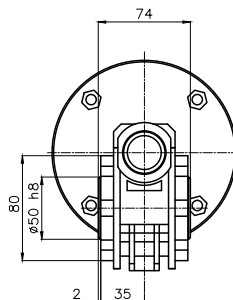

Gearbox Dimensions

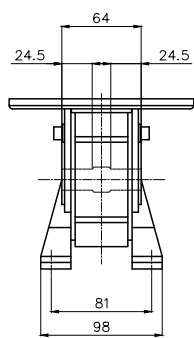

V

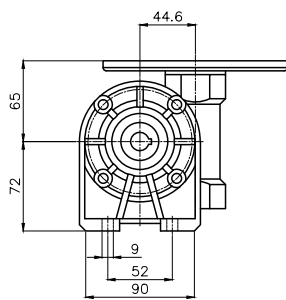

F

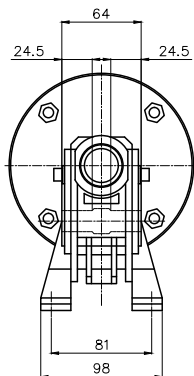
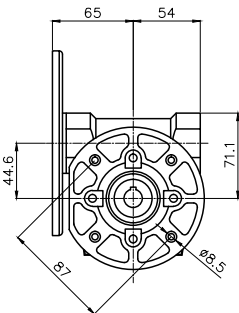
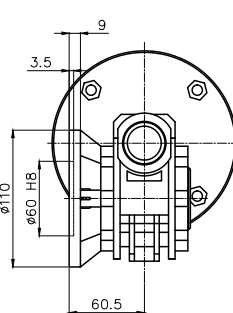

N

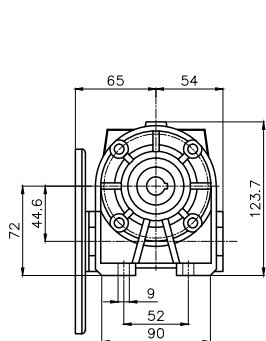

FA

